

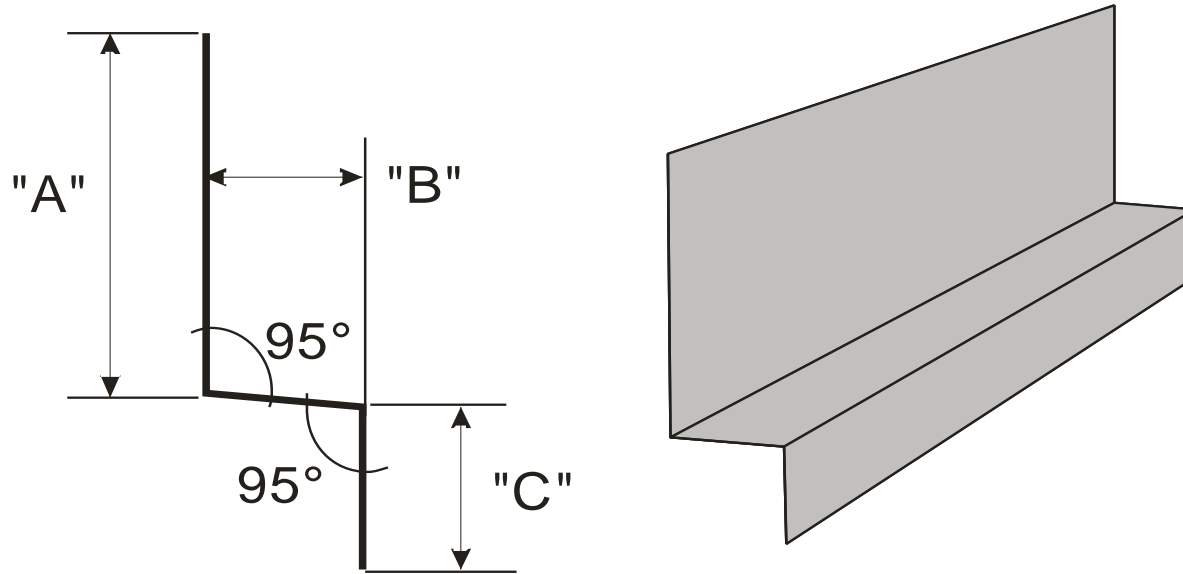

TAMLYN PRODUCT SUBMITTAL



UNLESS OTHERWISE SPECIFIED, STANDARD FABRICATION TOLERANCES APPLY.				TITLE:		1/2" X 7/16" X 1-1/16" 10' Z Flashing	
"A" (INCH) :	1.0625	GAUGE:	32 GA	 R.H. TAMLYN & SONS, LP 13623 Pike Road, Stafford, TX 77477 PHONE: 281-499-9604, FAX: 281-499-8948			
"B" (INCH):	0.4375	THICKNESS (INCH):	0.01				
"C" (INCH):	0.5	PERIMETER (INCH):	2				
LENGTH (INCH):	120	MATERIAL:	GALVANIZED	DATE:	08/31/12	PART #	ZB716
WEIGHT (LBS):	0.68		ASTM A 653 G90	DRAWN BY:	CK	APPROVED BY:	