

C39. WBT10

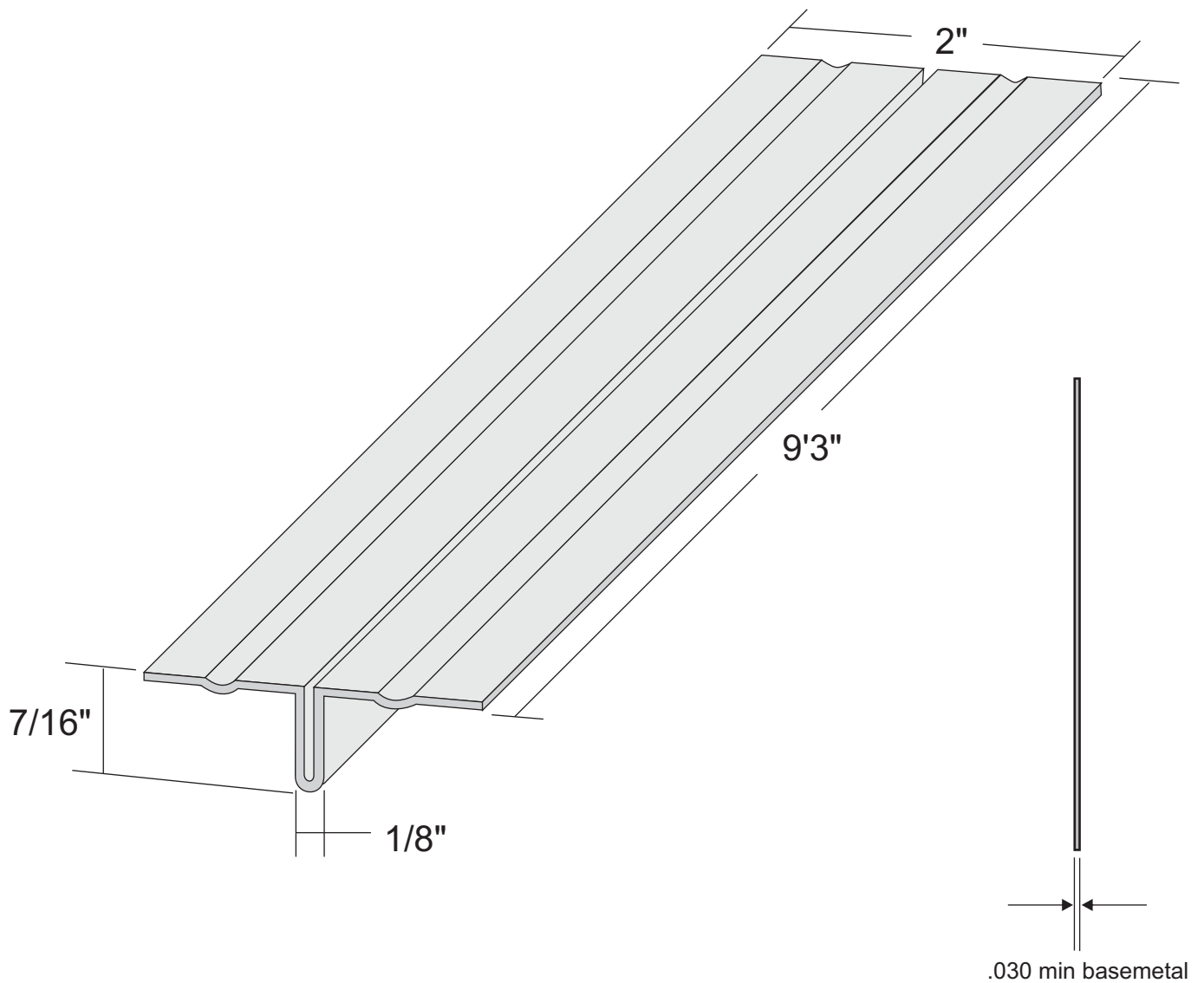

PRODUCT ID : **WBT10 - "T" Wall Brace**

WEIGHT (LBS) : **2.48**

DIMENSION : **2" W x 9'3" L**

MATERIAL : 22 ga. (.030 min basemetal) x 2.625" Galvanized Steel ASTM A653 G90 FY/FU=33/45 ksi min

NAILS: **5**

BOX #: **RHT-30**

QTY./BOX : **20**

BOX WT. (LBS) : **49.6**

CARTON UPC# **63225980081-2**

PRODUCT UPC# **63225950110-8**